



**COMPUTER
CONVERSIONS
CORPORATION**
www.computerconversions.com

6 Dunton Ct., E Northport, NY 11731 (631)261-3300 Fax. 261-3308

PCI-SYNCHRO™ SERIES
PCI 2.2 COMPLIANT
SYNCHRO-RESOLVER-ENCODER-LVDT
PCI BUS CARD OVERVIEW

FEATURES

- Synchro, Resolver & LVDT Converters
- Mix/Match 8 In. 3/Output Sets/Card
- 100% Transformer Isolated I/O Option
- Cards with Resident Force Test Ability
- Proven Standard "Whole" Converters
- Reliable Register Based "LSI" Logic
- Incremental Encoder Output Options
- On Board AC Reference Supplies
- True 32 Bit Long-Word Level Interface
- No External Supplies Required
- Software 98/NT+ Driver & Demo Pack

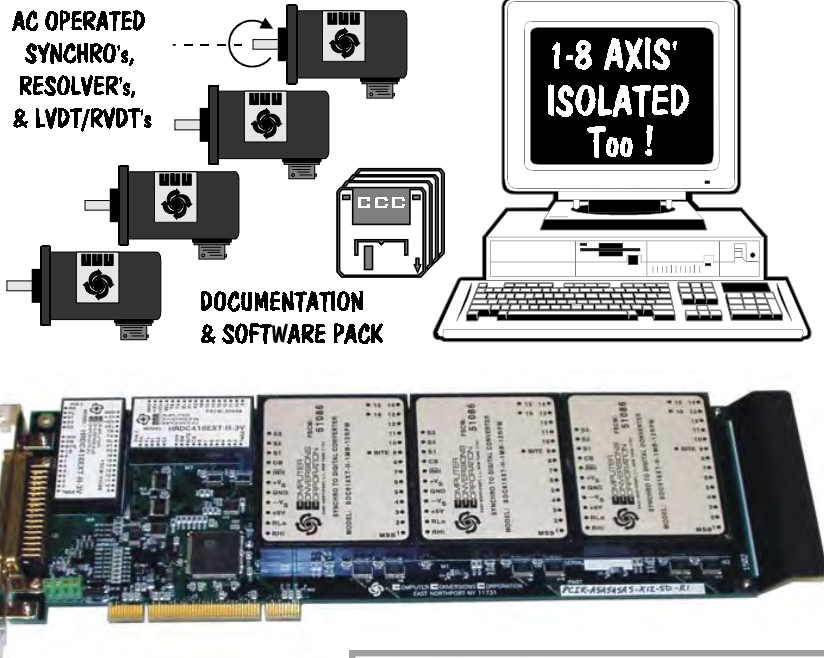

Overview

The PCI-Synchro™ Series" product line are full size **PCI 2.2 compliant** synchro, resolver, and LVDT I/O cards, and resolver-sensor card sets used as absolute encoder systems.

These cards are ideally suited for both industrial and COTS military concerns using any PCI bus compatible computer for simulation, ATE, "Absolute" position sensing and motion control, coordinates & process control, navigation, GPS, data acquisition, radar, ships speed indicators, antenna & targetting applications.

The PCI-Synchro™ Series converters provide up to 4 and **8 channels** of **Isolated Synchro/Resolver LVDT/RVDT** or **absolute encoder** interface on a single, standard full size 2 PCI printed circuit card.

Computer Conversions' full line of standard, proven "whole" Synchro/Resolver input and output type converters, **CT's and CDX's etc...** are used to populate the same standard PCI compliant CCA's.

Differing **converters may be mixed** to minimize real estate of any type. Both industrial and COTS military grade (**extended**) **temperature** range versions are available.

100% Transformer **Isolation** is offered for **all AC I/O**, and various Isolated DC

converters are available as standard product, **eliminating** concerns for **ground-loops**, ground interjected (intermittent and ghostly) **field noise**, **inductive surges**, differing potentials, and **high voltage field transients** from **effecting** the card itself, **the sensitive PCI bus backplane** and **any other device or system sharing these signals**.

Maximum **versatility** has been employed on all PCI-Synchro™ products to assure the universal compatibility in addressing, timing, system, and specific computer **hardware, software, and backplane independence**.

All PCI-Synchro™ cards are configured with full plug and play capabilities, and are ideally suited to real-time applications because there is no PCI-Bus latency. The interface is a solidly-reliable / high-speed, true **32 bit "Long-Word-Level"** register access.

Status registers are provided for various levels of **fault indication**, **Built-in-Test** (where applicable), and configuration criteria.

A sample demonstration program written in Visual C++ is provided with source code, which may be easily modified by the user for his/her particular application.

CONVERTER FUNCTIONS AND STANDARD I/O SELECTIONS

- Absolute Encoder Systems
- Synchro/Resolver To Digital
- Digital To Synchro/Resolver
- Syn/Res Control Transformers
- Multispeed & Multiturn Systems
- Synchro/Resolver Differentials
- Real-Time Control Differentials
- Absolute & Incremental Outputs
- DC Sin/Cos & Vector Generator's
- Digital Modulators & Demod's
- Active Coordinate Converters
- LVDT/RVDT Conversion
- Isolated A/D's & D/A's

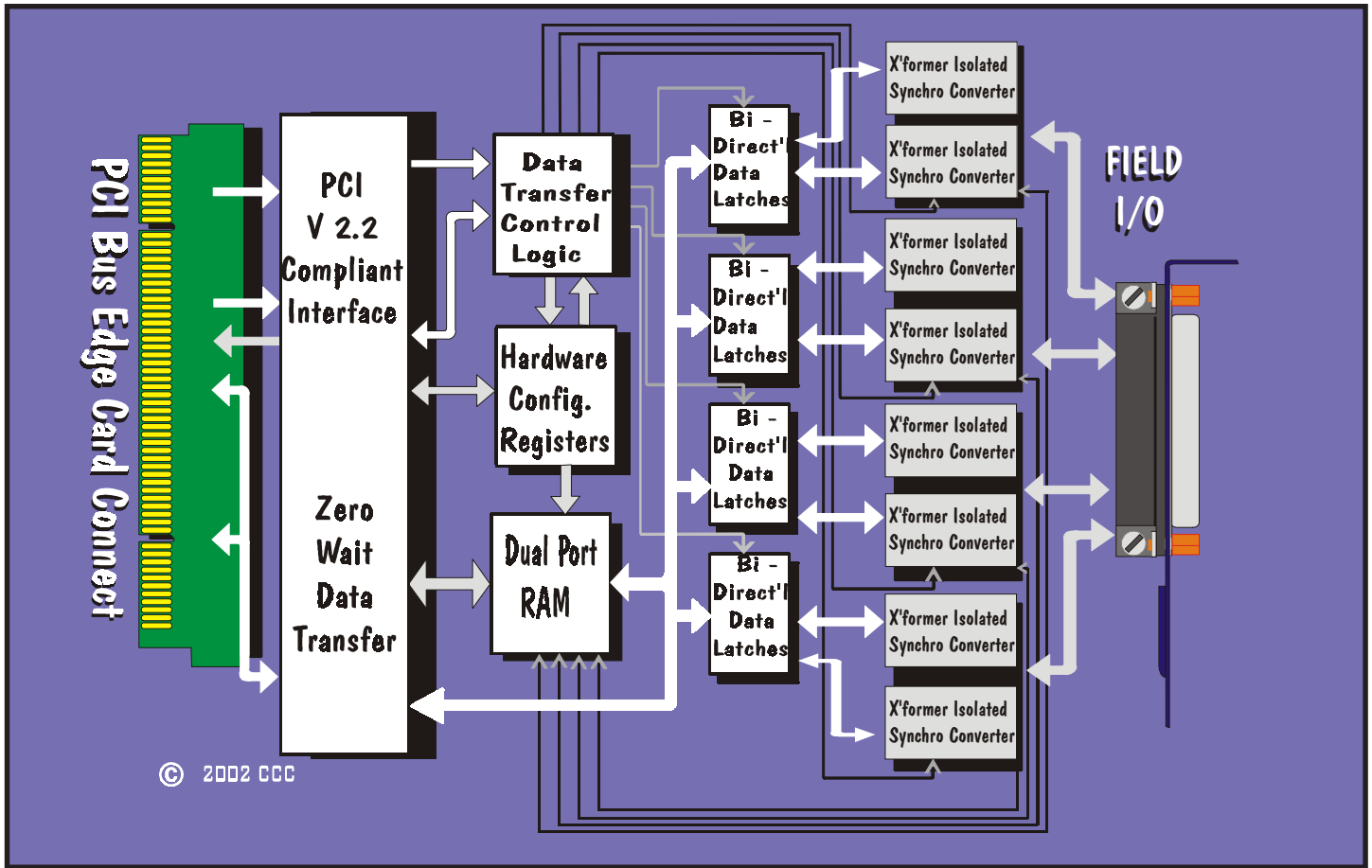

Base	Chan.	ADDRESS MAP FOR STATUS BITS IN THE HIGH WORD																ADDRESS MAP FOR DATA BITS (LOW WORD)																LSB																	
		31	30	29	28	27	26	25	24	23	22	21	20	19	18	17	16	15	14	13	12	11	10	9	8	7	6	5	4	3	2	1	0																		
0h	0	FLT	CP	WR													180	90	45																																
04h	1	FLT	CP	WR													180	90	45																																
08h	2	FLT	CP	WR													180	90																Data Bits, MSB Word Aligned, D0 = LSB = .0055 degrees																	
0Ch	3	FLT	CP														180	90	45																																
10h	4	FLT	CP														180	90	45															SEE CHANNEL ADDRESS LEFT																	
14h	5	FLT	CP														180	90	45																																
18h	6	FLT	CP														180	90	45															Unsigned Integer, Binary Weighted Angle																	
1Ch	7	FLT	CP														180	90	45																																
20h	CW																																E2 E1 E0 TB TA TB TA TB TA TB TA R2 R1 R2 R1 R2 R1 R2 R1																		
		Not used, shaded area = Bits not used, mask on reads, write zero's on write .														1 = Enable External				Channels 3 & 7				Channels 2 & 6				Channels 1 & 5				Channels 0 & 4				Channels 3 & 7				Channels 2 & 6				Channels 1 & 5				Channels 0 & 4			
FLT		Input (S-D) Channels 1 = Loss of Signal/Reference & Overspeed., Writes = External Synchro Amplifier Built-In-Test Fault = 1														Amplifier Outputs, E0 = Channel 0 E1 = Channel 1 E2 = Channel 2				Models with -WS Option, = With Forced Angle Self Test:																Models With Programmable Resolution:															
CP		1 = Channel Present Status Report																		TB TA = 00 = Normal Run Mode																R2 R1 = 00 = 10 Bits															
WR		1 = Write type Converter, i.e. Digital to Synchro, else input converter function i.e.S-D																		TB TA = 01 = 90.0 Degrees Angle, +/-0.1																R2 R1 = 01 = 12 Bits															
CW		CONTROL LWORD Details																		TB TA = 10 = 0.0 Degrees Angle, +/-0.1																R2 R1 = 10 = 14 Bits															
																				TB TA = 11 = 30.1 Degrees, +/-0.1 Degrees																R2 R1 = 11 = 16 Bits															

The demonstration program (with source code) is provided for **Out-Of-The-Box testing, without any user programming required.**

All cards may be user configured **completely Bus-Powered**, with **no external power supplies required.** Power source jumpers are provided to select the ±12VDC power source as

"Bus-Powered" or as external inputs via the I/O connector port. The use of "proven whole converter" modules assures the user of guaranteed system accuracy and dynamics ability, long term conversion integrity and stability. All wiring is made through standard or 50 pin "D" style connectors.

Isolated D-A/ A-D Converters, Digital Modulators, Demodulators, AC Reference Supplies, & related function converters may used with these cards. The availability of synchro/resolver I/O on the ISA bus, allows the user to configure his systems with resident test ability, switched manual or automatic self test, and simulation type programs.



**COMPUTER
CONVERSIONS
CORPORATION**
www.computerconversions.com

6 Duntun Ct, E Northport, NY 11731 (631)261-3300 Fax: 261-3308

PCI-SYNCHRO™ SERIES SYNCHRO, RESOLVER, & LVDT INPUT CHANNELS

Description

The PCI-Synchro™ cards facilitate up to 8 isolated input channels, and are 1-8 continuously tracking synchro or resolver to IBM PC/AT™ card converters, employing type 2 ratiometric tracking converters for **high performance** applications.

They will accept any group of upto 8 individual, or 4 sets of paired multispeed; 3-wire **Synchro**, or 4-wire **Resolver** inputs, or **2-4 wire LVDT/RVDT inputs**; over a frequency range of **50Hz. to 10KHZ.**, and convert them into 10-16 bit words of natural binary data.

Data is addressable in a **long word 32 bit format** over the IBM PC/AT™ backplane. Data made available to the bus is continuously updated (tracking) without interruption; output **data is accurate, monotonic, and always fresh** up to the maximum tracking rate of the converter.

When the address is applied, and normal bus variables are set; the converters **data bits are latched simultaneously into separate buffered registers to prevent false reads.**

A **Forced Self-test feature is optioned "-WS"** that allows on program command an internal disconnect of inputs to read a 30° fixed analog test.

Applications

- Antenna Monitoring
- Closed Loop Servo Controls
- Fire Control Systems
- Avionic & Naval Systems
- Conveyor Controls
- Wind Speed Indicators
- Machine Control Systems
- Shaft Angle Encoding
- Engine Test Stands
- Material Handling Systems
- High Speed Data Acquisition

FEATURES

- Direct Synchro/Resolver/LVDT Inputs
- Transformer Isolated I/O Options
- High Speed, Stable, Ratiometric, Tracking Converters
- High Noise Immunity/Insensitive to Amplitude and Frequency Variations
- No External Parts or Power Required
- On-Board Reference Supply Options
- 10-20 Bit Resolution & Multispeeds
- Incremental Encoder Output Options
- True 16 Bit Word Level Interface
- Force Self-Test Option (-WS Units)

A continuous Built-In Test (BIT) output representing the tracking mode, Loss of signals, Loss of Reference, **for status report are provided for each input channel.**

No external transformers, modules or signal conditioners are required. The synchro/resolver converters used feature **internal solid-state or Transformer Isolated Scott T's** that accept **direct field voltage inputs.**

Isolation

Transformer isolated units are completely isolated from each other and the backplane for all the reference and signal lines.

This completely isolates the card and effectively the whole computer from all field wiring, and especially from any other device sharing these signals: eliminating concerns over; troublesome ground loops, ground induced noise, differing potentials, ground interjected spikes, and ghostly filed noise that so frequently takes down entire systems.

Bus Powered

No external supplies required! All units are available as **completely bus powered via the PCI backplane**

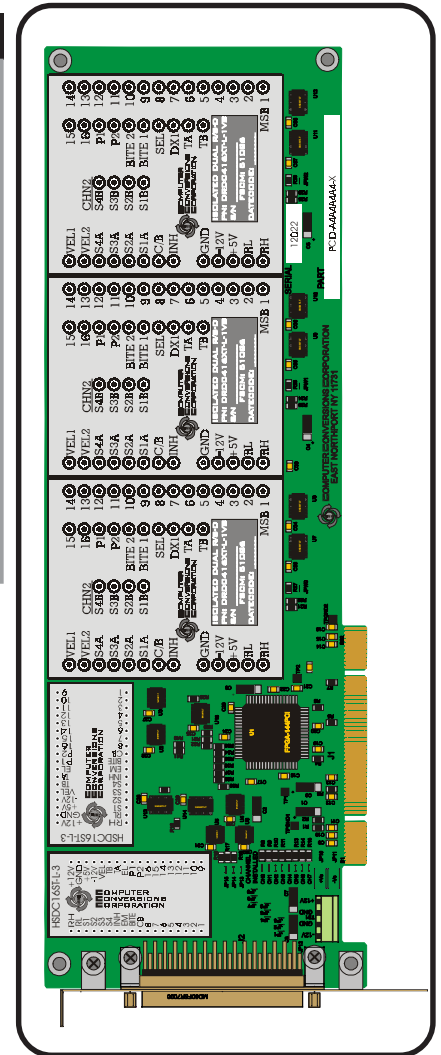

or as external inputs for the ±12VDC supplies. Power required is ±12, +3, and +5VDC, and the source is for the +/-12VDC is strap selectable for power sourcing via the ISA backplane or as external power via the I/O connector.

Options currently available include: DC velocity outputs, internal reference supplies, quadrature pulse train outputs, high reliability and mil-grade extended temperature range units. Units with on-board DC-to-DC converters also available.

Additionally, PC/AT cards can be configured to meet particular OEM requirements. Many perspective custom applications can be configured with 100% standard product.

Specifications for all Input Cards/channels

SPECIFICATIONS						
Resolution		10 Bits	12 Bits	14 Bits	16 Bits	18-20
Accuracy		+/-30'	+/-8.5'	+/-4'+1LSB	+/-4'	+/-1'
<i>-GA Models</i>				+/-4.5'+1LSB		
<i>-HA Models</i>		+/-21'		+/-2.7'	*+/-2.6'	+/-10sec.
<i>-HAI Models</i>					+/-40"+1LSB	
Tracking Rate	60Hz.	12.5	10	2.5	0.625	0.25
	400Hz.	40	40	10	2.5	1
	2.5KHz.+	100	80	30	5	1.2
<i>-HS models</i>	2.5KHz.+	200	200	50	10	
Acceleration		770	295	20		
	400Hz.	12600	4500	610	124	
<i>for a 1 LSB lag</i>	2,5KHz.	2500	9000	1620		
		1400	350	70		
	400Hz.	22000	5500	1100		
	2,5KHz.+	160K	40000	8100		
Step Response	60Hz.	200ms.	360ms.	800ms.	1200ms.	
	2.5KHz.+	95ms.	95ms.	150ms.	600ms.	2000ms.
Frequency Range	60Hz.units	47-1000Hz.		400Hz.units 360 - 2000Hz.		
	2.5KHz. units	2000-4.8KHz.		Units to 10KHz. available		
Reference Inputs	26VRMS into 90K ohms					
	115VRMS into 360K ohms					
Signal Inputs	11.8VRMS L-L into 26K ohms Minimum L-L Balanced					
	26VRMS L-L into 26K ohms Minimum L-L Balanced					
	90VRMS L-L into 200K ohms Minimum L-L Balanced					
Breakdown (volts)	500 VDC Minimum to Ground on Transformer Units					
Common Mode	80 Db. Minimum on Solid State Units					
Power Supplies	+3VDC @ .4 Amp. typical, +5 VDC @ 120 ma./channel					
	+12VDC @ 35 ma./channel, -12VDC @ 45 ma./channel (-12 units)					
	or, +15VDC @ 25 ma./channel, -15VDC @35 ma./channel					
Temperature	0C to +60C on card level units, 0C to+70C on parts., (-1 units)					
(operating):	-40C to +75C on card level units, -40C to +85C on parts, (-3 units)					
(Storage):	-55C to +125C					

Notes:

1)All units available with either low cost solid state, or Transformer Isolated signal and reference inputs.

Transformer Isolation is highly recommended for all high voltage inputs, also when the signals are wired to more than one device or system, where ground loops or field noise may be significant for bus concerns, radar and antenna applications, and absolutely mandated for all Naval and most military concerns.

2)Accuracy applies over the operating temperature range, +/-10% amplitude and frequency variations, & +/-5% power supply variations.

3)Different input voltages and frequencies available, higher tracking rates and accuracy.

4)For all units any one input line may be grounded.





**COMPUTER
CONVERSIONS
CORPORATION**
www.computerconversions.com

6 Dunton Ct, E Northport, NY 11731 (631)261-3300 Fax. 261-3308

PCI-SYNCHRO™ SERIES OUTPUT CHANNELS

OPTIMUM THERMAL MANAGEMENT

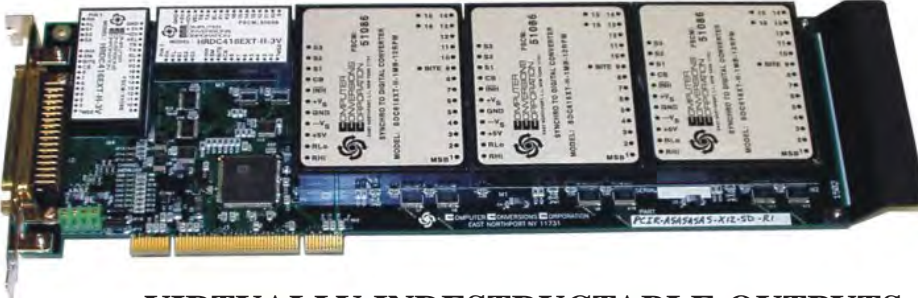

VIRTUALLY INDESTRUCTIBLE OUTPUTS

Description

The PCI-Synchro™ output channels are complete **PCI to Synchro and Resolver** output converters used for self-test, simulation, and control in military and industrial applications.

The PCI card is populated by 1-3 **Industry Standard™ Digital to Synchro and/or Digital to Resolver Converters, CT's or CDX's** mixed as specified for the application.

32 Bit long word level double buffered inputs are provided on each channel and addressable via independent or successive addresses.

The **true 32 Bit architecture** allows the converters to be written to as single word writes, **without** any fear of low-byte/high-byte **ambiguities**.

All of these converters feature virtually **indestructible short-circuit proof outputs, overvoltage and transient protection, internal solid-plate heat sinks, and automatic thermal cutoff.**

Complete transformer isolation is provided on all reference inputs and signal outputs to: eliminate ground loops, differing potentials, and to keep any high voltage transients from affecting the PCI backplane.

Both low cost **“DSL/DRL Series”** and reference powered **“DSP Series”** converters are offered to drive on-board loads

of up to 4.5VA and external “booster amplifiers” are available to drive **loads up to 150VA.**

DSL/DRL TYPE CONVERTERS

The **DSL/DRL** series are **low cost models** that are powered from either $\pm 15VDC$ or optionally $\pm 12VDC$ supplies. The DC supply source may be field selected as sourced by an external input or **Bus Powered from the PC/AT backplane.** The power supplies should be verified as capable of providing the required current.

Standard $\pm 12VDC$ units drive 1.2VA loads, and standard $\pm 15VDC$ units drive 1.5VA loads. Higher drive models are available.

Frequencies of 400Hz. and higher require no external components, and two different types of output transformers are offered for 50-60Hz. units.

Applications

- Fire Control Systems
- Naval Trainers
- Aircraft Simulators & Trainers
- Navigational Tools & GPS Systems
- Gyro & Wind Speed Simulation
- Test Stands & Instrumentation
- Automated Test Equipment

FEATURES

- Proven "Whole" Std. Converters
- Optimized Thermal Management
- External Synchro Amp I/O
- 100% Transformer Isolated I/O
- Permits 2 Wire X/Y Stators (Air)
- No External Parts or Power Req'd
- Reference Powered Options
- 10-16 Bit Resolution Progrm.
- Virtually Indestructible Outputs
- 1.2 to 4.5VA Models
- True 16 Bit Word Level Interface
- Mix/Match Input & Output Types
- Simultaneous Fine/Coarse Transmit for Multispeed Outputs

FUNCTIONS

- Digital to Synchro/Resolver
- Vector Generators(& DC Sine/Cos)
- Solid State Control Transformers
- Dual Channel Synchro Amplifiers
- Isolated D-A's Mod's/LVDT Out's
- Mix/Match w/S-D/R-D's On-Board
- Real Time, In-the-Loop, Active Control Differentials, CDX's
- Reference Powered D-S's
- Dynamic S/R & Vector Rotators

These units occupy one full size with a singlewidth slot.

Absolute value, vector units, "active" Differentials, Dynamic Rotators, & 2-10KHz. models, are available as standards for motor control apparatus and realtime simulators.

DSP TYPE CONVERTERS

DSP series 60Hz. units don't require any external transformers, and drive all 50, 60 & 400 Hz. loads.

The **DSP series** derives the output power from the reference (RH, RL) input and requires no ± 15 or ± 12 VDC supplies. This series features a very efficient, internal pulsating power supply that converts the reference input into a high-power, angle-weighted, synchro output format.

400Hz. DSP units drive up to a full 4.5VA load, and 60Hz. units drive a full 1.5VA load direct without requiring external output transformers

The DSP units occupy one full size doublewidth slot (DSP modules are .8"H).

OTHER CONVERTERS

By looking at the model selection guide you will notice the PCI Series models, allow the choice of both Read and Write type Converters. Units with Isolated Digital to Analog, or LVDT converters, multispeed conversion, Vector Generators, Control Transformers and Differentials etc...can be configured by requesting "IBB Series Extended Model Selection Guide" from the factory.

DSL/DRL Units; Model Type, Drive/Load Verses Power Supply Load

DC Power Supplies	+/-15VDC SUPPLIES						+/-12VDC SUPPLIES					
	External +/-18VMax.						.Bus-Powered or Ext.					
Frequency	60 Hz. Units			400 Hz. Units			60 Hz. Units			400 Hz. Units		
Model Type	**N	Std.	-3L	Std.	-3L	*-5L	**NL	Std.	-3L	Std.	-3L	*-5L
Drive (VA)	0.02	1.5	2.2	1.5	2.9	5	0.025	1.2	1.7	1.2	2	3.4
90V. Synchro in Kohms		4	2.7	4	2	1.2		5	3.5	5	3	1.78
11.8V. Syn in ohms				70	36					87	52	
11.8V. Res in ohms				93	48					116	70	
Avg. DC Current (ma.)	120	150		150			150	220		200		
Avg. Peak Current (ma.)	120	330		330			150	485		440		
Foldback (ma.)	120	600		600		2000	180	600		600		2000

- Notes: 1)** These units used to power external synchro power amplifiers, upto 300VA,
 2)* These units require double slot assy. for converter height & thermal considerations.
 3) All units require sufficient forced air cooling, thermal cut-off @125C auto-resume.
 4) 60 Hz. units require an external transformer, see dwg. below, for +/-15VDC powered units use P/N DSC60-15, for +/-12V powered units use P/N DSC60N.
 5) The +/-12 or +/-15VDC supplies should feature fold-back current limiting to insure that they gradually increase the voltage with load surge caused during power on. Most reasonable supplies (including most switchers) features feature this.
 6) Both the + and - supplies should power up simultaneously to minimize power surges (typical of all class B amps.) Tracking supplies should be considered where practice.

Standard Synchro Loads

MIL-STD Class MIL-S-20708	Impedance ZSO	Load VA
26v 08 CT 4c	100 + j490	0.2784
26v 11 CT 4d	21.0 + j132	1.0417
11 CT 4e	838 + j4955	1.6118
15 CT 4b, & c	1600 + j9300	0.8584
15 CT 6b, & c	1170 + j6780	1.1773
18 CT 4b, & c	1420 + j13260	0.6074
18 CT 6b, & d	1730 + j510	4.491
23 CT 4, & a	1460 + j11050	0.7267
23 CT 4b, & c	1950 + j14000	0.573
23 CT 6, & a	1250 + j3980	1.9417
23 CT 6c & d	1350 + j4300	1.7972

Notes: 1) 6 = 60 Hz., 4 = 400 Hz. units
 2) 26V = 26Vsystem, 11.8VL-L signals else; 115Vsystem, 90VL-L signals typ

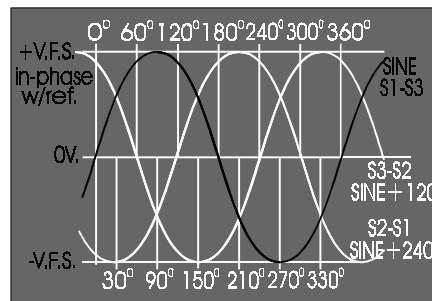

Synchro Signals

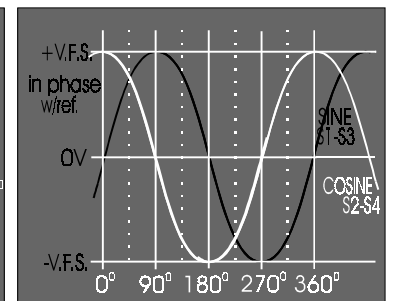

Resolver (sine/cosine)

©Copyright
 CCC 2001, 2002

50/60 Hz. Transformer P/N DS60N
 For DSL/DRL Type 50/60 Hz. units

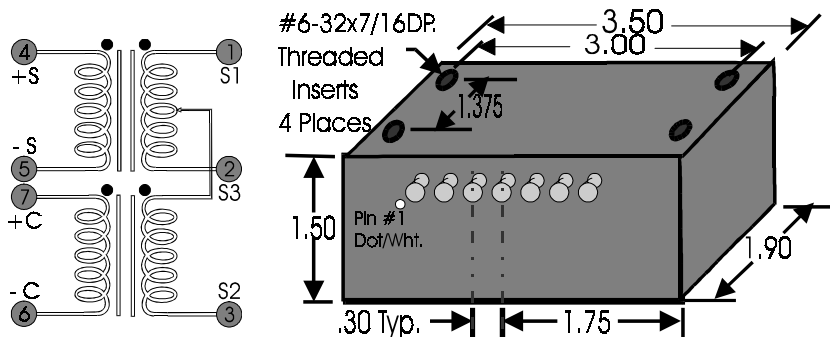

Accuracy:

12 bit units ± 15 arc minutes

accuracy applies over operating temp. range, $\pm 10\%$ amplitude & frequency

14 bit units ± 4 arc minutes

variations, $\pm 5\%$ variation power supplies, $\pm 10\%$ harmonic distortion

16 bit units +/-2.3 arc minutes, -HA units +/-1' +1LSB,

* Models upto 20KHz. available



COMPUTER CONVERSIONS CORPORATION
 6 Dunton Ct., E. Northport, NY 11731 www.computerconversions.com Phone (631)261-3300 Fax 261-3308

Environmental Specifications:

Temperature:

Operating:

- 1) 0 - 70°C, 0 - 60°C installed
- 2) -40 to +85°C

Storage:

-55 to +125°C

Humidity: 0 to 95% (non-condensing)

Vibration: 3.5 mm. 5-9Hz. :
1.0 G 9 - 150Hz.

Shock: 15 g's for 11 msec.

Typical Cable:

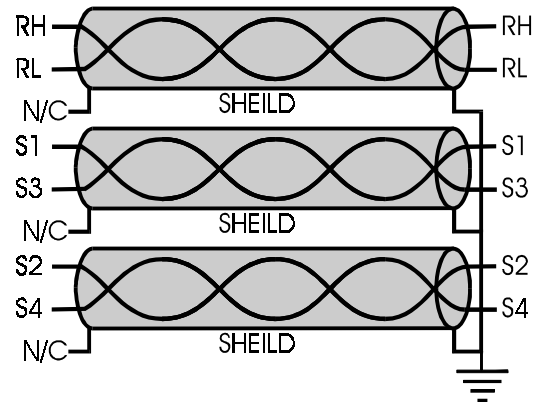

Notes:

- 1) Screw circuit card mounting bracket to chassis prior use.
- 2) All shields to go direct to Earth Ground on the computer side only.
- 3) To reverse direction of rotation swap S1 with S3 or invert data in software.
- 4) S4 is not used on Synchro units.
- 5) J10 and J11 jumpers are installed on Bus-Powered units. They must be removed if external ± 12 or ± 15 VDC supplies are being applied to the TBI Terminal Block. See Picture showing address jumpers for J9, J10 locations.
- 6) When using non-reference powered D-S/D-R converters or cards with internal reference supplies; make sure supply provides ample -12 or -15VDC depending on model.

PIN TERMINATIONS: PCI Series Units.

PIN #	IBD SERIES High Density	D-S/R Amp. Support	S/R-D QM Option	PIN #	IBD SERIES High Density	D-S/R Amp. Support	S/R-D QM Option		
38	RH	Reference	RH	46	RH	Reference	RH		
5	RL		RL	13	RL		RL		
36	S1		S1	44	S1		S1		
3	S2		Signals Channel 0	S2	11		S2	Signals Channel 2	S2
19	S3			S3	27		S3		S3
35	S4			S4	43		S4		S4
21	S1	Signals Channel 4		B-	29	S1	Signals Channel 6		B-
37	S2		B+	45	S2	B+			
4	S3		A-	12	S3	A-			
20	S4		A+	28	S4	A+			
18	OPT.		*V0:RL4	M+	26	OPT.		*V2:RL6	M+
2			*V4:RH4	M-	10			*V6:RH6	M-
42	RH	Reference	RH	50	RH	Reference	RH		
9	RL		RL	17	RL		RL		
40	S1		S1	48	S1		S1		
7	S2		Signals Channel 1	S2	15		S2	Signals Channel 3	S2
23	S3			S3	31		S3		S3
39	S4			S4	47		S4		S4
25	S1	Signals Channel 5		B-	33	S1	Signals Channel 7		B-
41	S2		B+	49	S2	B+			
8	S3		A-	16	S3	A-			
24	S4		A+	32	S4	A+			
22	OPT.		*V1:RL5	M+	30	OPT.		*V3:RL7	M+
6			*V5:RH5	M-	14			*V7:RH7	M-
1	DC COMMON			34	DC COMMON				

IF MULTISPEED: Pair Fine/Coarse: Channels: 0/1, 2/3, 4/5, 6/7.

J3 Connector AMPHENOL# DDH-50SAM4 Mate Souriau # D50P 032N MIL M24308/3-5 50 Pin D

©Copyright CCC 2001,2002



COMPUTER CONVERSIONS CORPORATION
6 Dunton Ct., E. Northport, NY 11731 www.computerconversions.com Phone (631)261-3300 Fax 261-3308



**COMPUTER
CONVERSIONS
CORPORATION**
www.computerconversions.com

6 Duntun Ct, E Northport, NY 11731 (631)261-3300 Fax. 261-3308

PCI-SYNCHRO™ SERIES MODEL SELECTION GUIDE

Model:

PCI -
 B 4 -
 B 4 -
 K 4 -
 K 4 -
 X12

a b a b a b a b OPTIONS
 CH.0 CH.1 CH.2 CH.3

SELECT BASE CARD STYLE::

PCI = EITHER INPUT OR OUTPUT TYPES

***PCID = HIGH DENSITY CARDS**

* Note: PCID Series High Density Cards Use 2 Input Converters per Input Channel Selection.

1st. Select Base Card Style Inputs/Outputs above "IBR,IBW"

2nd. Select Function/Resolution code "table a) below "A-U"

3rd. Select Signal Code "table b)" to your right "1-9"

4th. Add Additional channels or "00" for none

5th. Add an "X" for ISOLATION and options

a) *******RESOLUTION*******

BITS	16	14	12	10
-------------	-----------	-----------	-----------	-----------

Table a) Resoluionn/ Function

SYNCHRO TO DIGITAL (SDC) TYPE

Code	A	B	C	D
------	----------	----------	----------	----------

RESOLVER TO DIGITAL (RDC TYPE)

Code	E	F	G	H
------	----------	----------	----------	----------

DIGITAL TO SYNCHRO (DSL) TYPE

Code	J	K	M	N
------	----------	----------	----------	----------

DIGITAL TO SYNCHRO (DSP) TYPE REF.PWRD

Code		P	
------	--	----------	--

DIGITAL TO RESOLVER (DRL) TYPE

Code	R	S	T	U
------	----------	----------	----------	----------

ALL OTHERS REQUEST EXTENDED MODEL GUIDE

b) SELECT SIGNALS (INSERT CODE #)

REFERENCE VOLTAGE	SIGNAL LEVELS	FREQUENCY IN HERTZ	INSERT THIS CODE
26VAC	11.8V. L-L	400 Hz.	1
26VAC	11.8V. L-L	2.6KHz.	2
26VAC	26V. L-L	400 Hz.	3
115VAC	90V. L-L	400 Hz.	4
115VAC	90V. L-L	60 Hz.	5
*115VAC	*7V. L-L	400Hz.	6
*115VAC	*7V. L-L	60 Hz.	7
*26VAC	*7VL-L	400Hz.	8

ALL OTHERS REQUEST EXTENDED MODEL GUIDE

NOTES: * 1) These Converters typically used to drive power amplifiers, 6V. L-L with +/-12V. bus power

Example: Model; PCI-B4B4K4K4-X12

Includes: 1 PCI 2.2 Compliant Card,
 Populated with 2 14 Bit S-D Converters (B4B4)
 and, 2 14 Bit D-S Converters (K4K4)
 All Reference inputs 115VAC @ 400Hz. (B4/K4)
 All the Signals are 90V.L-L @ 400Hz. (B4/K4)
 All Reference & Signals Transformer Isolated (X)

±12VDC may be powered by the AT Bus. (12)

- | | | |
|---|--|--|
| <p>Options: ADD:</p> <ul style="list-style-type: none"> -8 For Independent References on PCID's -HS For High Speed -GA or HA Accuracy | <ul style="list-style-type: none"> - X For Transformer Isolation -12 For ±12 verses ±15VDC Power Inputs, (±12 for Bus Powered) -M For Multispeed Operation -Q Quadrature Incremental Encoder Outputs | <ul style="list-style-type: none"> -V For DC Velocity Outputs - 1 For 0°C to +70°C Oper. Temp. - 2 For -55°C to +105°C Oper. Temp. - 3 For -40°C to +85°C Oper. Temp. -WR For With Reference Supplies |
|---|--|--|